



SPECIFICATIONS

200NH-E*300BHC CC DRIVER

Model: 200NH-E*300BHC

Power: 200W

Rev.: V01

Release date: 2026-04-28

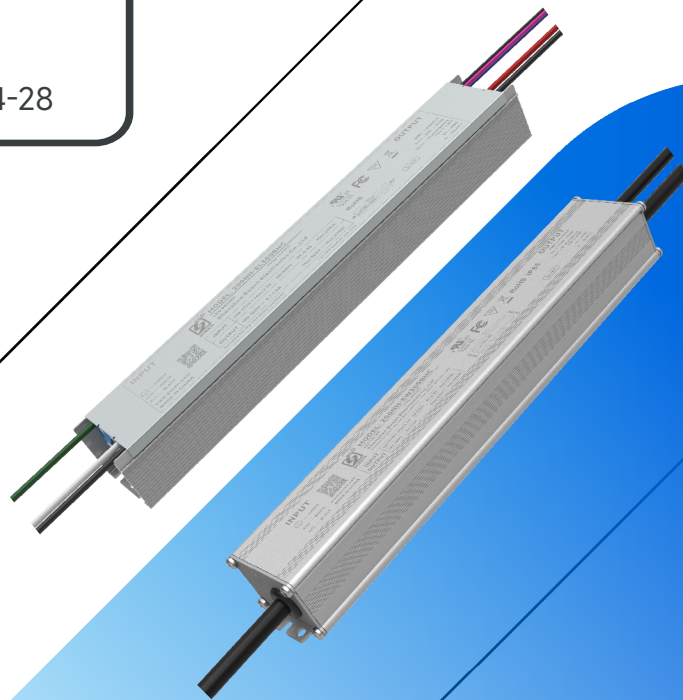

200NH-E*300BHC Series LED Driver

Features

- Efficiency up to 96%
- Dimming: 0-10V,PWM,Resistor,Timing
- Isolated Dim-to-off
- AUX Power: 12V/0.2A
- Soft-start, Constant Lumen, Life Warning
- Standby power<0.5W
- Protections: SCP/OTP/OVP
- Surge protection: CM: 6kV, DM: 6kV
- Dual-live-wire input off without afterglow
- Warranty: 5 years

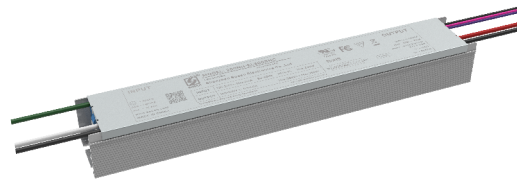

200NH-EL300BHC



200NH-EW300BHC(IP65)



RoHS

Description

200NH-E* series are 200W non-isolated constant current LED Driver with 108-305VAC. It has DIM to Off, high efficiency, isolated auxiliary power supply, compact housing, high reliability, high cost performance and other advantages.

Applications:
Plant lighting

Model List:

Model	AC Input Range	Max. Pout	Vout Range	Full Power Vo Range	O/P current	THD(Typ.)	PF(Typ.)	Eff.(Typ.)	Max.Tc
200NH-E*300 BHC	108-305Vac	200W	170-300V	200V-300V	0.1-1.0A	8%	0.97	96%	90°C

- Note:
- 1.Default Tested: at 230Vac, full load, Ta 25°C.
 - 2.The performance of the LED Driver can be guaranteed within the full power Vo range.The voltage lower than full power Vo range,it is need to test the performance with the LED module.

200NH-E*300BHC Series LED Driver

“*” Means Additional Function

“*”	AUX 12V (suffix:H)	Dimming off 0-10V/PWM/Resistor	Timing	Dual-live-wire input off	IP65	Remark
L	✓	✓	✓	✓		
W	✓	✓	✓	✓	✓	

Input Characteristics:

Parameter	Min.	Typ.	Max.	Remark
Rated AC Input Range	120Vac		277Vac	Full load
AC Input Range	108Vac		305Vac	Ref. derating curve
Input Frequency Range	47Hz	50/60Hz	63Hz	
Max Input Current			2.3A	120Vac, Full load
Max Input Power			230W	120Vac, Full load
Max Inrush Current(120Vac)			60A	Cold start
Max Inrush Current(220Vac)			130A	Cold start
Max Inrush Current(277Vac)			130A	Cold start
Standby Power			0.5W	230Vac/50Hz, Dim-to-off
Power Factor	0.95	0.97		220Vac/50Hz, Full load
	0.90			120-277Vac, 70%-100% load
THD		8%	10%	220Vac/50Hz, Full load
			20%	120-277Vac,70%-100% load

200NH-E*300BHC Series LED Driver

Output Characteristics:

Parameter	Min.	Typ.	Max.	Remark
O/P Voltage Range	170V		300V	Power derated @170-200V
Rated O/P Voltage	200V		300V	$P_o=V_o \cdot I_o=200W$, Full load
Rated O/P Current	0.66A		1.0A	1.0A for 200V,0.66A for 300V
Adj. O/P Current (AOC)Range	0.1A		1.0A	
No Load Voltage			350V	
Efficiency @120Vac/60Hz	91.0%	93.0%		Output 300V/0.66A
Efficiency @230Vac/50Hz	94.0%	96.0%		Output 300V/0.66A
Efficiency @277Vac/50Hz	94.0%	96.0%		Output 300V/0.66A
O/P Current Tolerance	-5%		+5%	
O/P Current Ripple(PK-AV)		5%	10%	Full load
Start-up Current Overshoot			10%	Full load
Start-up Time			0.5S	120Vac,Full load
			0.5S	220Vac,Full load
Line Regulation	-2%		+2%	Full load(Low temperature $\pm 5\%$)
Load Regulation	-6%		+6%	
Temperature Coefficient	-0.03%/°C		+0.03%/°C	T _c :0°C~90°C
OTP	90°C	95°C	100°C	>T _c Typ., Current derating <T _c Min., Current recovery
Short Circuit Protection				Driver will not be damaged

200NH-E*300BHC Series LED Driver

Other Characteristics:

Parameter		Min.	Typ.	Max.	Remark
Aux Power	O/P Voltage	10.8V	12V	13.8V	
	O/P Current			200mA	
0-10V Dimming (Optional)	Dim Vmax	0V		12V	Negative dimming by programming Dimming prohibits reverse connection. DIM+ source current 110uA .
	Dim Range	10%loset		100%loset	
	Rec.Dim Range	0V		10V	
PWM Dimming	PWM High	9.8V		10.2V	DIM+ source current 110uA.
	PWM Low	0V		0.3V	Dimming prohibits reverse connection
	Frequency	1KHz		2KHz	
	PWM Duty	0%		100%	
Resistor Dimming	Resistance	0Kohm		100Kohm	DIM+ source current 110uA.
	Dim Range	10%loset		100%loset	
Dim to Off	Dim off	0.7V	0.8V	0.9V	
	Dim on	0.8V	0.9V	1.0V	
Timing Curve(Optional)		By programming			Set by program
Constant Lumen(Optional)		By programming			Set by program
Life Warning(Optional)		By programming			Set by program
Lifetime(Tc≤75°C)		≥50,000 hours			220Vac,80% load
MTBF		190,100 hours			220Vac,Full load, Ta=25°C (MIL-HDBK-217F)
IP Grade		IP65			200NH-EW300BHC
Tc		90°C			
Warranty		5 years			Tc:75°C
Net Weight		650g			200NH-EL300BHC
Net Weight		900g			200NH-EW300BHC
Dimension(L x Wx H)		262mm*36mm*30.5mm			200NH-EL300BHC
Dimension(L x Wx H)		260mm*42mm*31mm			200NH-EW300BHC

NOTE: All the parameters above are tested Ta 25°C and LED load, unless specified.

200NH-E*300BHC Series LED Driver

Environmental Requirements

Parameter	Min.	Typ.	Max.	Remark
Operating Temperature(Tcase)	-40°C	25°C	+90°C	
Storage Temperature	-40°C	25°C	+90°C	
Operation Humidity	10%RH		90%RH	
Storage Humidity	5%RH		90%RH	
Altitude	-65m		4000m	

Safety and EMI/EMS Standards

Certification	Standard	Status	Remark
UL	UL8750	✓	
CUL	CAN/CSA C22.2 No.250.13	✓	
ENEC	EN 61347-1 EN 61347-2-13 EN IEC 62384		
RCM	AS/NZS61347.2.13		
CCC	GB/T 19510.1 GB/T 19510.213		
CE	EN 61347-1 EN 61347-2-13 EN 62493		
	EN 301 489-1 EN 301 489-3 EN 300 330 EN 62479/EN 50663/EN 50665/EN 50364		For NFC wireless products

200NH-E*300BHC Series LED Driver

Safety and EMI/EMS Standards

EMI/EMS	Standard	Status	Remark
Conduction Emission	FCC Part 15 Subpart B;ANSI C63.4	✓	120Vac/277Vac:Class A
Radiation Emission	FCC Part 15 Subpart B;ANSI C63.4	✓	120Vac/277Vac:Class A
Harmonic Current Emissions	EN IEC 61000-3-2	✓	ClassC
Surge	IEC/EN61000-4-5	✓	DM: 6kV,CM: 6kV,Criterion B
	ANSI/C82.77-5	✓	DM: 6kV,CM: 6kV,Criterion B
Ring Wave	IEC/EN 61000-4-12	✓	DM: 6kV,CM: 6kV,Criterion B
	ANSI/C82.77-5	✓	DM: 6kV,CM: 6kV,Criterion B

200NH-E*300BHC Series LED Driver

Safety Test Items:

Safety Test Items	Technical Indicators	Remark
Insulation Requirements	UL Insulation Requirements	
Input-Case	2U+1000Vac	Basic insulation
Input-Dim	2U+1000Vac	UL Basic insulation
Dim-Case	500Vac	Basic insulation
Insulation Resistance	$\geq 10M\Omega$	Input-Dim, Test voltage: 500Vdc
Ground Resistance	$\leq 0.1\Omega$	25A/1min
Leakage Current	$\leq 0.75mA$	277Vac

NOTE:

- 1.SOSEN warrants the LED Driver itself complies with EMC standard. However, LED Driver's EMC should be re-checked when integrated into lighting systems due to unexpected interference of components.
- 2.Please short (ACL and ACN), (V+ and V-), (Dim+ and Dim - and Vaux+ and Vaux-)when Hi-pot test.
- 3.During the HI-POT, the built-in GDT and the ground connection terminal wire shall be disconnected.

Performance Curves:

Input Inrush Current

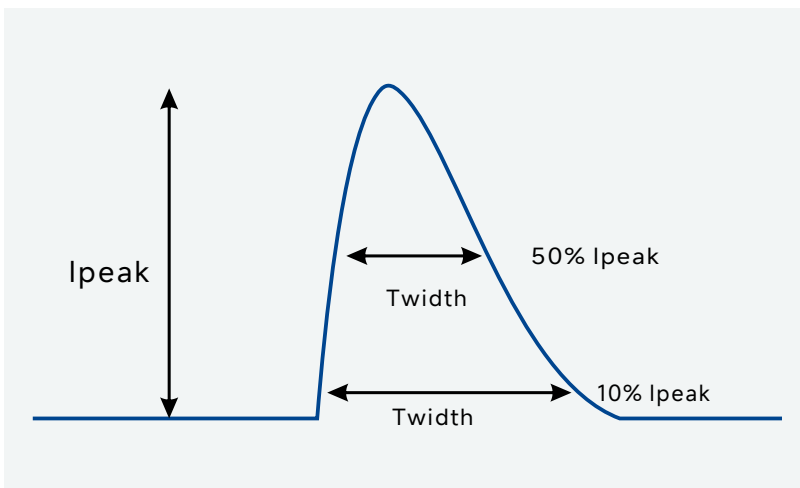

Vin	Ipeak	T(@10% of Ipeak)	T(@50% of Ipeak)
120Vac	60A	800uS	250uS
220Vac	130A	650uS	230uS
277Vac	130A	600uS	230uS

200NH-E*300BHC Series LED Driver

Performance Curves:

Output Voltage Vs. Output Current(Dim/AOC Window)

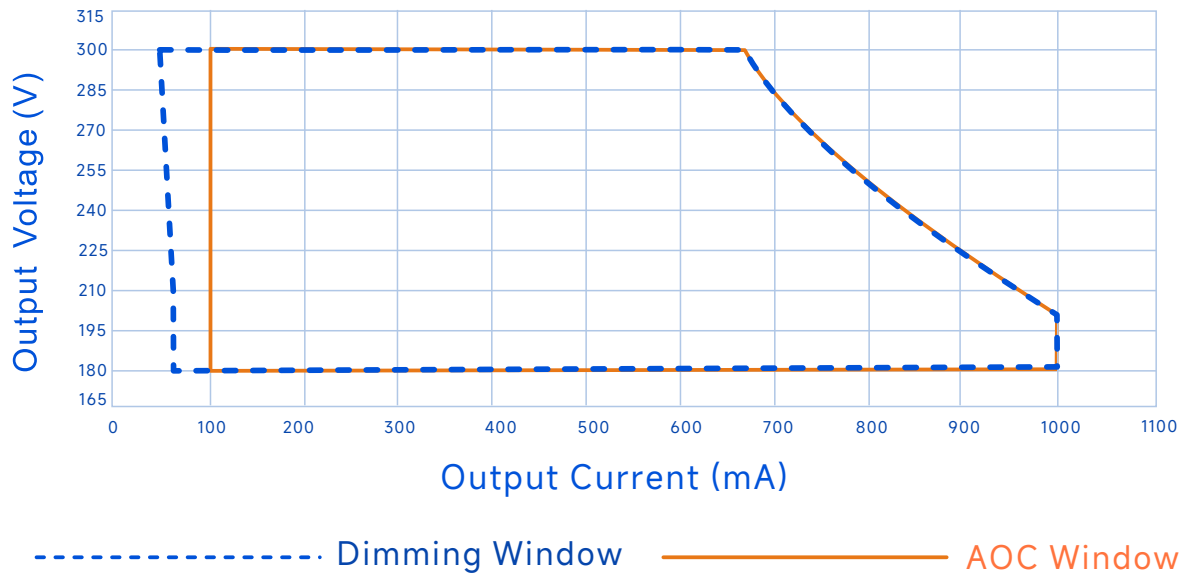

Efficiency Vs. Output Voltage (Vin=120Vac)

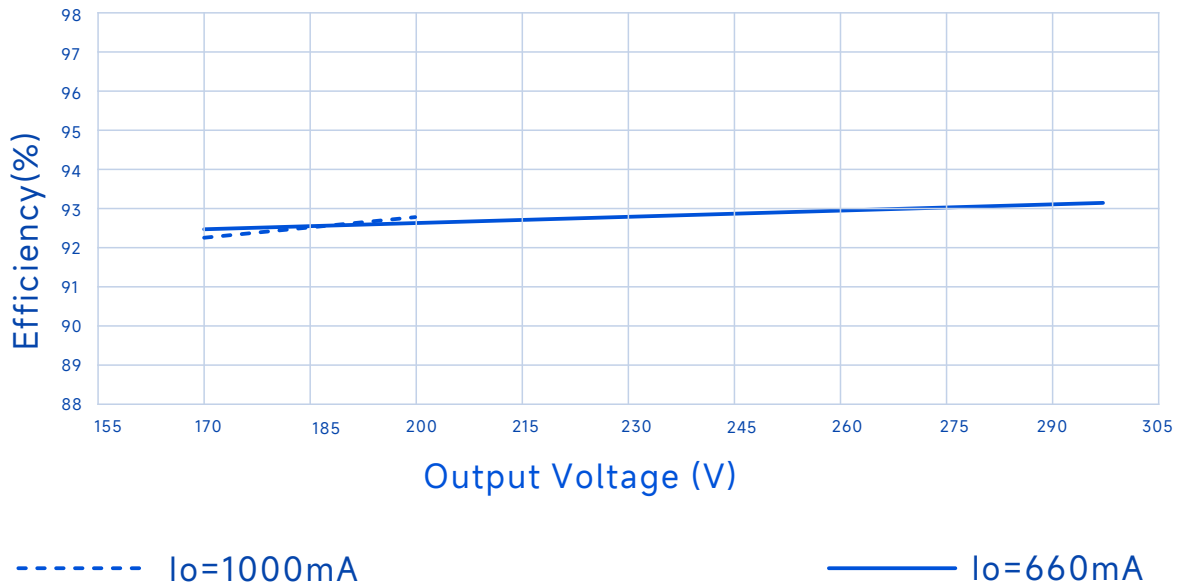

200NH-E*300BHC Series LED Driver

Performance Curves:

Efficiency Vs. Output Voltage ($V_{in}=230V_{ac}$)

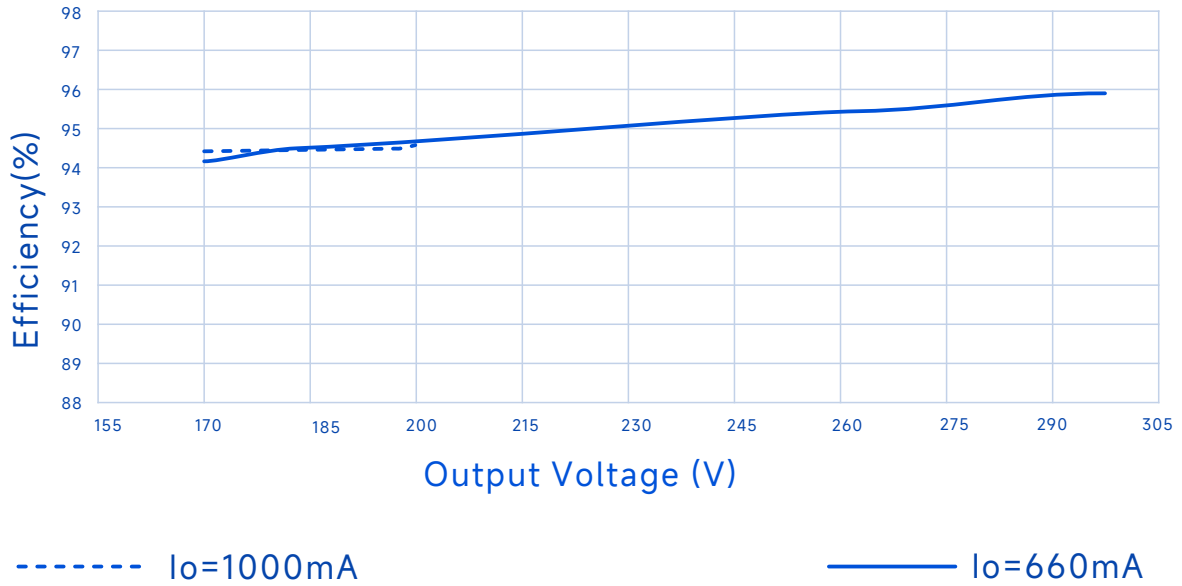

Efficiency Vs. Output Voltage ($V_{in}=277V_{ac}$)

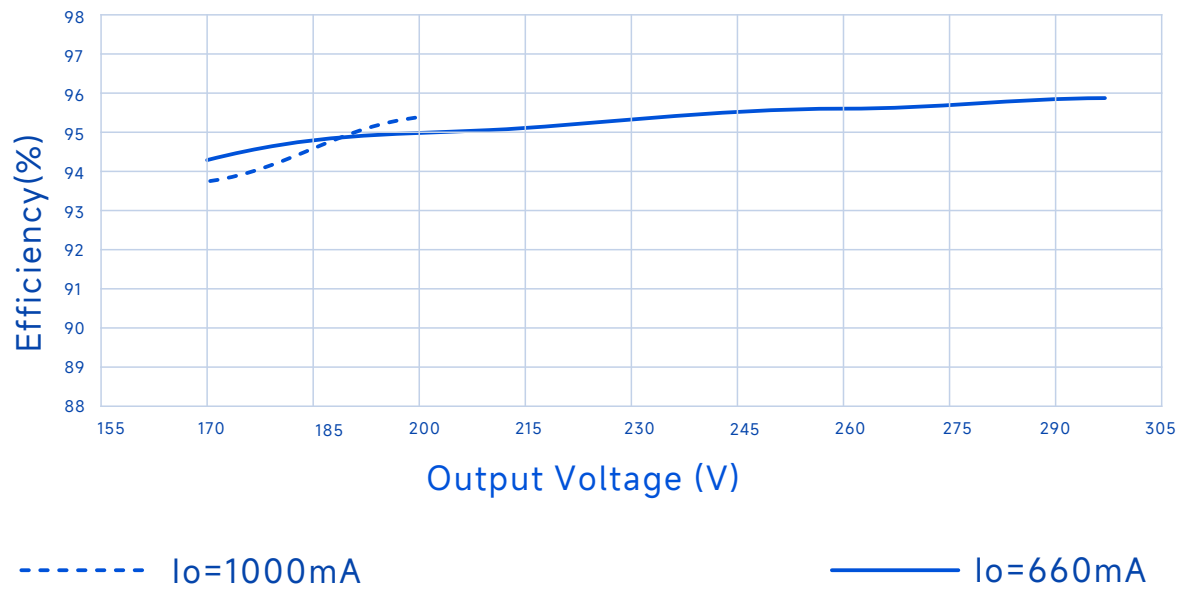

200NH-E*300BHC Series LED Driver

Performance Curves:

Power Factor Vs. Output Power

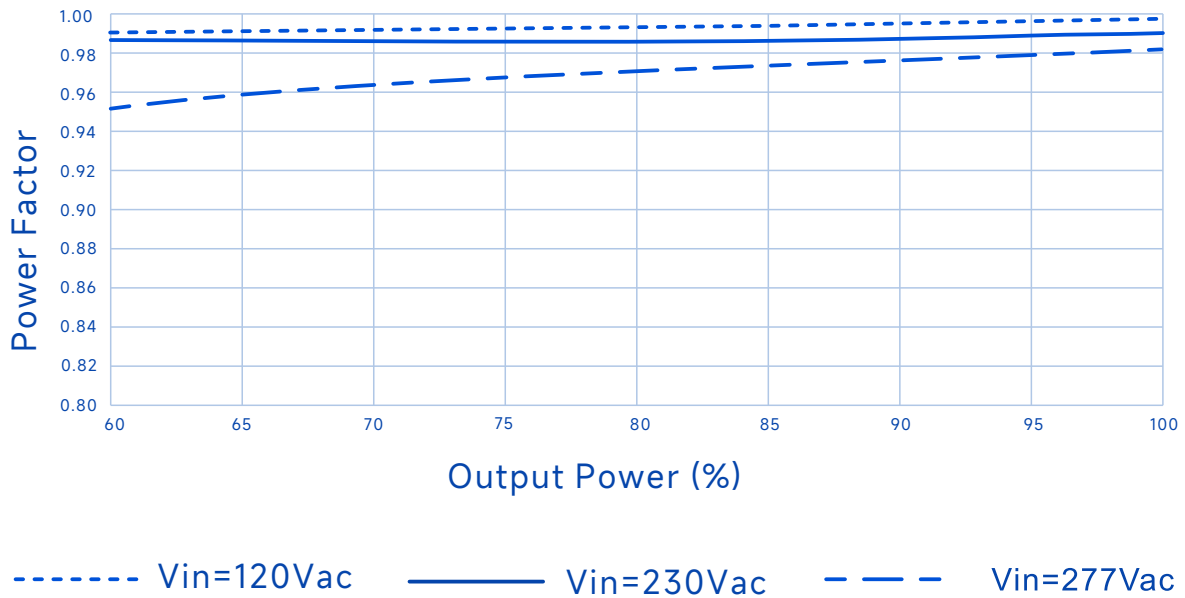

THD Vs. Output Power

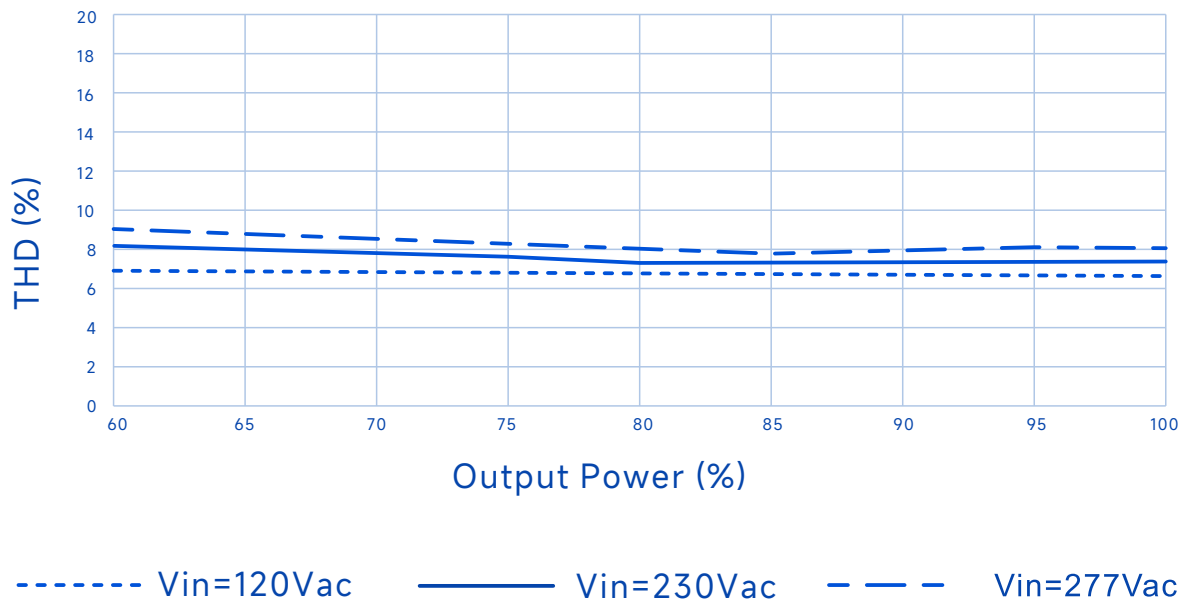

200NH-E*300BHC Series LED Driver

Performance Curves:

Output Power Vs. Input Voltage

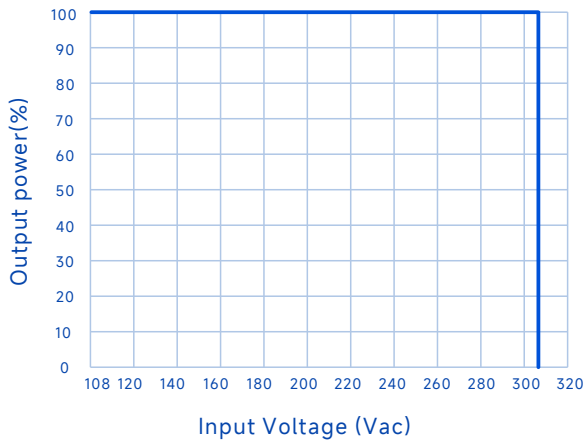

Output Power Vs. Case Temperature

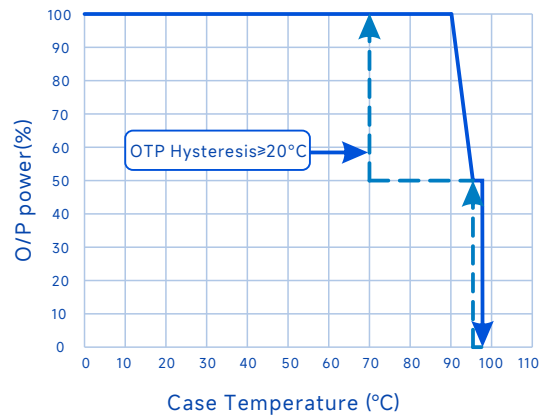

Output Power Vs. Dimming

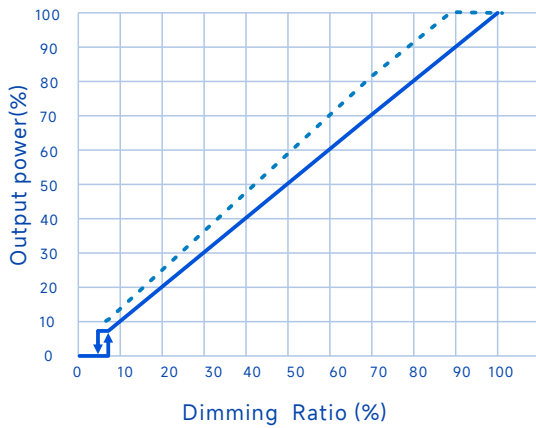

- 0-10V, PWM
- Resistor Dimming

Lifetime Vs. Case Temperature

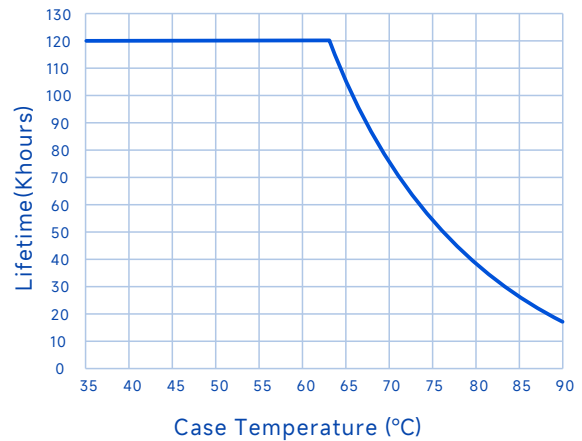

200NH-E*300BHC Series LED Driver

Software TOP function

The software OTP is an optional feature, and the OTP parameters can be set through the software page.

Timer Dimming

Automatic conversion between DST and Standard Time. Traditional Timer Dimming, Self-Adapt-Midnight Timer, Self-Adapt-Percentage Timer. The time dimming percentage can be set by setting 8 curves.

Traditional timer: After power-on, it works according to the set timing curve (Increasing fade time allows for slow changes between different dimming levels, preventing sudden changes in brightness and causing dazzle)

Self Adapting-Midnight: Automatically save power-on times and use 2 valid timers to assume that the center point of the dimming curve is local midnight time.

Self Adapting-Percentage: Runs the initially set dimming curve according to an automatically calculated adaptive cycle time.

CLO Constant Lumen Output

Light failure compensation function, in the Luminaire life cycle, by gradually increasing the output current, to achieve a constant output of LED luminous flux, the overall luminous effect remains unchanged.

ELA End-of-Life Alert

By presetting a LED driver life time, such as 50KH, after the luminaire has accumulated 50KH of light-up time, every time the luminaire is powered on, it will blink 4 times to remind the user to replace the LED driver.

SSA software startup

By setting the soft start time, the lamp gradually lights up slowly within the set time, thus achieving the purpose of protecting the lamp.

Programming connection diagram

1. During programming, the driver does not need to be powered on to achieve all programming functions.
2. For a driver that is powered on and in use, all programming functions can be performed without needing to disconnect the power.
3. It can operate independently of a PC to achieve offline programming.

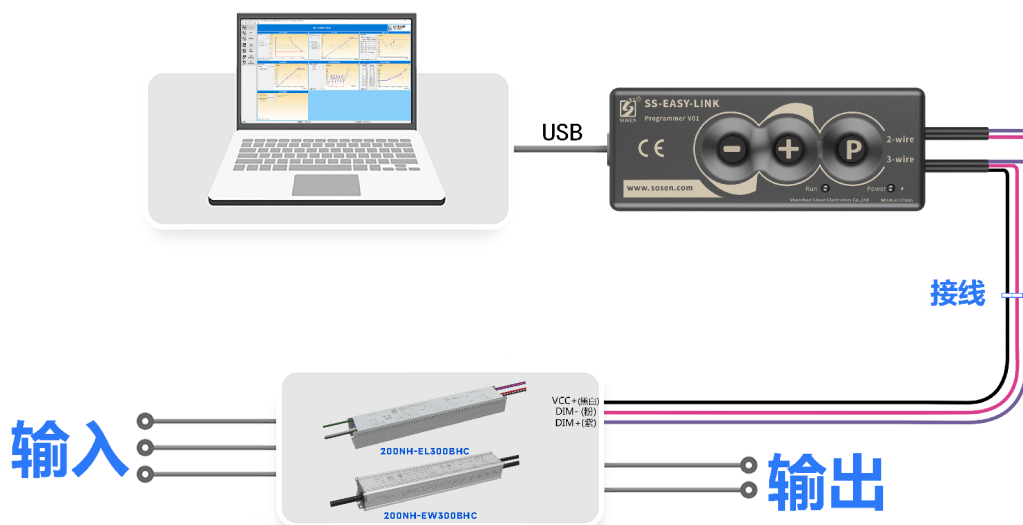

12/17

200NH-E*300BHC Series LED Driver

Parameter			Remark
Default setting	Positive logic dimming (0-10V)	Dimming voltage default 10V (source current)	Factory Default Model
Dimming optional function	Positive logic dimming (0-10V) Turn off the Constant current source	Dimming voltage default 0V (sink current) Resistance dimming not available	When the dimming wire is not connected, the LED driver output is in the DIMOFF state

Note:

Select "Dimming voltage defaults to 10V (source current)" / "Dimming voltage defaults to 0V (sink current)", which needs to be set according to the dimmer used by the end user.

Settings Interface

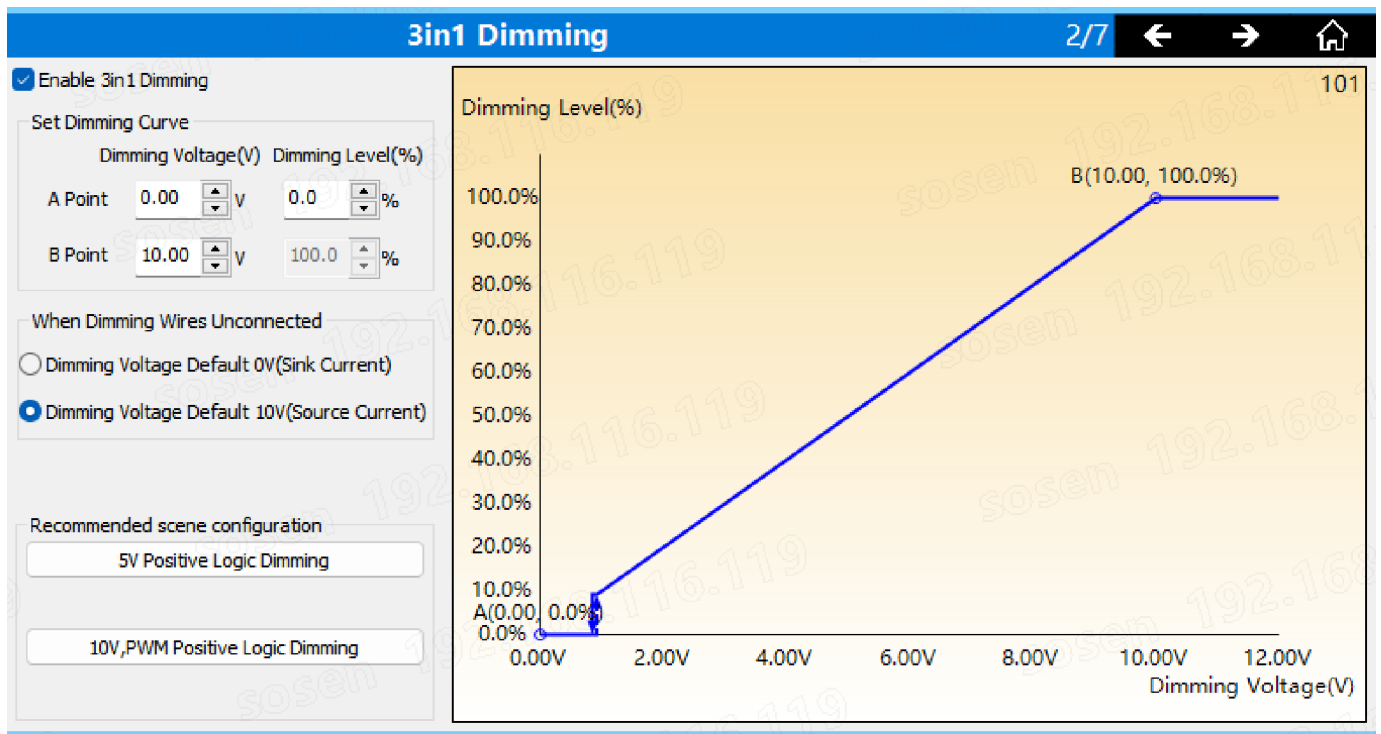

200NH-E*300BHC Series LED Driver

Mechanical Characteristics(200NH-EL300BHC)

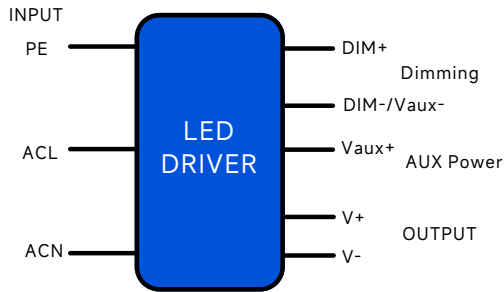

AC Input Cable(Exposed Length 300±10mm):

UL model:18AWG 105°C 600V O.D: 2.77mm,Black:ACL,White:ACN,Green:

DC Output Cable(Exposed Length 300±10mm):

UL model: 18AWG 105°C 600V O.D: 2.77mm,Red:V+ Black:V-

DIM/AUX Power Cable (Exposed Length 220±10mm):

UL model: 22AWG 105°C 300V O.D: 1.52mm Purple DIM+, Pink: DIM-/Vaux- Black/White: Vaux+

Name Description	Standard Code	mm(in.)
Overall Length	L1	262(10.31)
Mounting Hole Length	L2	251(9.88)
Case Width	W1	36(1.42)
Mounting Hole Width	W2	20(0.79)
Case Height	H	30.5(1.20)
TC Point Position	X	112(4.41)
TC Point Position	Y	18(0.71)

Note

- Please follow the "LED Driver User Manual" obtained from SOSEN's official website for assembly.
- AC Input Cable,DC O/P Cable,DIM Cable:Tinned length of wire:10±2mm

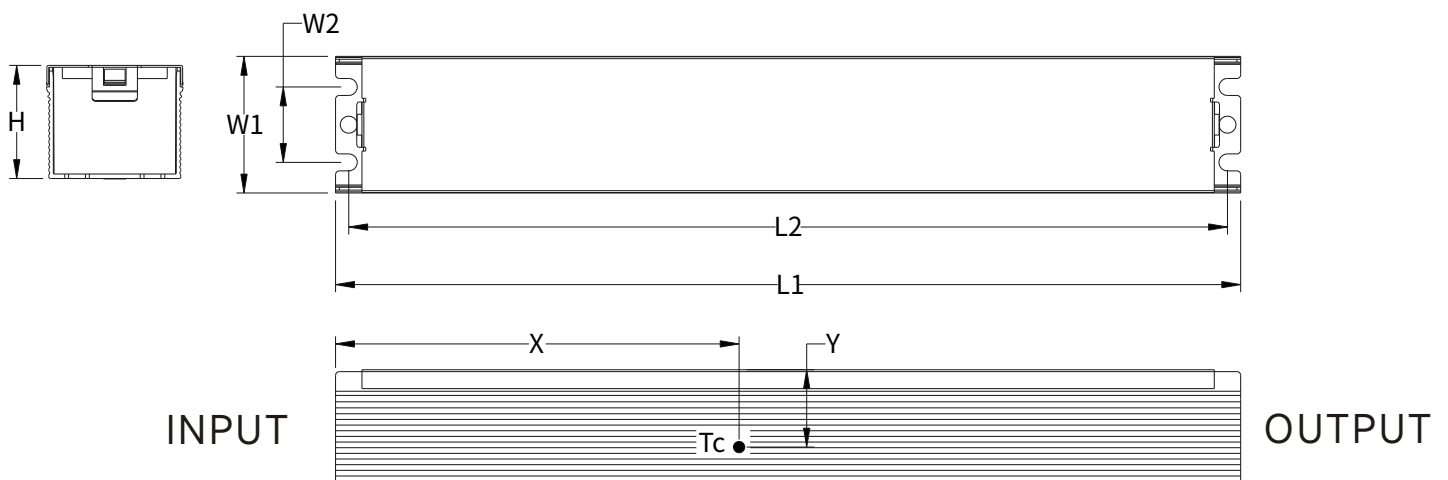

200NH-E*300BHC Series LED Driver

Mechanical Characteristics(200NH-EW300BHC)

AC Input Cable(Exposed Length 450±10mm):
 UL/EU model:3C PVC SJTW 3*18AWG 105°C 300V O.D: 7.8mm
 Black:ACL,White:ACN,Green:⊕

DC Output Cable(Exposed Length 250±10mm):
 UL/EU model: 2C PVC SJTW 2*18AWG 105°C 300V O.D: 7.3mm
 Red:V+ Black:V-

DIM/AUX Power Cable (Exposed Length 220±10mm):
 UL model: PVC UL21996 3*22AWG 105°C 300V O.D: 4.9mm Purple DIM+
 Pink: DIM-/Vaux-,Black/White: Vaux+

Name Description	Standard Code	mm(in.)
Overall Length	L1	260(10.24)
Mounting Hole Length	L2	253(9.96)
Case Length	L3	246.4(9.70)
Case Width	W1	42(1.65)
Mounting Hole Width	W2	18.5(0.73)
Case Height	H	31(1.22)
TC Point Position	X	110(4.33)
TC Point Position	Y	21(0.83)

- Note
- 1.Please follow the "LED Driver User Manual" obtained from SOSEN's official website for assembly.
 - 2.AC Input Cable,DC O/P Cable,DIM Cable:Tinned length of wire:10±2mm
 - 3.The dimensional characteristics of the shell height: (unit: mm (in.), tolerance +1 mm (0.039 in.), -0.5 mm (-0.019 in.)
 - 4.The maximum dimensions of L1, L2, and L3 are shown in the table on the left for reference only.

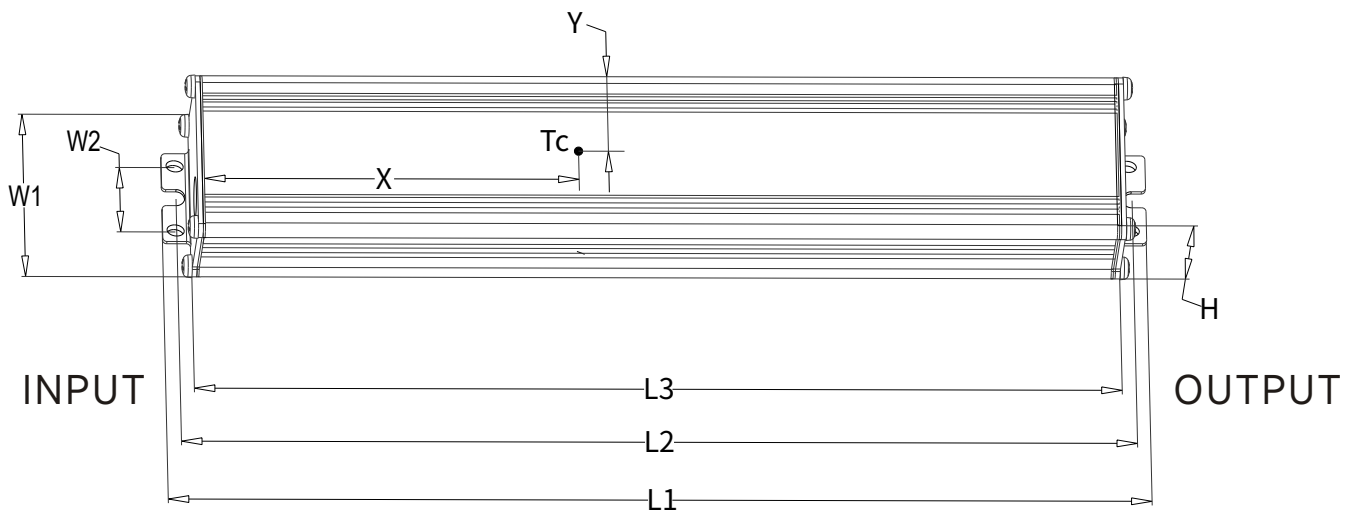

200NH-E*300BHC Series LED Driver



Assembly Tips

1. When the adjusting light or auxiliary power line is not in use, please seal the adjusting light connector with an insulating sleeve to prevent interference signals from entering. This causes damage to the dimming line or auxiliary power line, affecting the normal operation of the power supply.
2. The trace routing on aluminum substrates is designed in compliance with creepage distance requirements specified by relevant certification regulations.
3. The creepage distance between LED+ and LED- on the aluminum substrate is designed in compliance with the relevant certification regulations.
4. Minimize the copper area on the aluminum PCB to reduce parasitic capacitance and leakage current.
5. It is recommended to design LED beads in parallel first and then in series.
6. The insulation level of LED light panels should meet the reliability design requirements.
7. For other precautions, please refer to the "LED Driver User Manual".
8. SOSEN reserves the right of final interpretation of the above parameters.

Warning

Insufficient or compromised insulation voltage resistance in LED light panels may cause breakdown and short circuits to earth, resulting in damage to the luminaire and LED driver, and posing significant safety hazards. It is recommended to install a residual current device (RCD) during application.

Package

- Outside carton dimension: L×W×H =495×385mm×162mm;
16PCS/Carton;(200NH-EL300BHC)
- Outside carton dimension: L×W×H =577×385mm×162mm;
24PCS/Carton;(200NH-EW300BHC)
- Net weight/Piece:0.65kg;Gross weight/Carton: 13.0kg;(200NH-EL300BHC)
- Net weight/Piece:0.90kg;Gross weight/Carton: 17.0kg;(200NH-EW300BHC)
- Please refer to the product name, model number, manufacturer identification, QC PASS, manufacturing date on the package.

Transportation

Packaging is designed suitable for transportation by trucks, vessels and flights. The products should be avoided direct sunlight and rain, loaded/unloaded with caution.

Storage

The product storage meets the standard of the GB 3873-83.
Products should be rechecked if stored for over 1 year before assembly.

RoHS

Products comply with RoHS Directive (2011/65/EU) and amendment 2015/863/EU.

